

# **2024 CATALOG**

# **LIQUID FERTILIZER / SPRAY SUPPLIES**

**STORAGE TO FIELD - WE HAVE YOU COVERED**

- 
- HOSE
  - PUMPS
  - VALVES
  - ENGINES
  - FITTINGS
  - NOZZLES
  - SPRAYERS
  - STRAINERS
  - CAMLOCKS
  - TANKS/LIDS
  - HANDWANDS
  - NOZZLE BODIES

**FAMILY OWNED AND OPERATED SINCE 1962**

**580-234-3434  
800-299-4300**

**5606 N. US 81 HWY,  
ENID, OK. 73701**

**WAKOLLC.COM**



# INDEX

<b>DESCRIPTION</b>	<b>PAGE NUMBER</b>
<b>SPRAYERS</b>	<b>2-5</b>
<b>SKIDS &amp; SADDLES</b>	<b>6</b>
<b>TANKS</b>	<b>7-9</b>
<b>BULKHEADS</b>	<b>10</b>
<b>TANK LIDS</b>	<b>11</b>
<b>PUMPS</b>	<b>12-18</b>
<b>ENGINES</b>	<b>19-20</b>
<b>BALL VALVES</b>	<b>21</b>
<b>FITTINGS: POLY, CAMLOCK, FLANGE</b>	<b>22-29</b>
<b>NOZZLE BODIES</b>	<b>30-32</b>
<b>NOZZLE ACCESSORIES</b>	<b>33</b>
<b>MISCELLANEOUS SPRAY SUPPLIES</b>	<b>34</b>
<b>STRAINERS</b>	<b>35-36</b>
<b>HOSE</b>	<b>37</b>
<b>HOSE REELS</b>	<b>38</b>
<b>HANDWANDS</b>	<b>39-40</b>
<b>SPRAY NOZZLE TIPS</b>	<b>41-45</b>
<b>GARDEN MENDING</b>	<b>46</b>



# WAKO H1000 FIELD CRUISER

## Spray with confidence!

### Features:

- Frame-Tough 4" x 6", heavy wall tubing
- Booms: Autoglide Boom Suspension. 4 point spring and shock suspension allows booms to float smoothly over the roughest terrain.
- Nozzles: Dripless DCV Nozzle Bodies
- Hydraulic boom height adjustment from the cab
- Hydraulic fold from the cab
- Directional Hydraulic Valve for trouble free folding.
- 3" Ball and socket for smooth pulling.
- 4 Flotation Tires-16.5L x 16.1, 10 Ply, Farm Implement Tires
- Breakaway Wings: (In case you hit a pole)
- 1000 Gallon Elliptical Tank with Sump
- 2" Ground Fill for Tank
- Pump: Ace Hydraulic Centrifugal or John Blue Ground Drive



### Options:

- Electronic Cab Controls
- Guidance System
- Ground Drive Pump or Hydraulic Centrifugal Pump
- Agitation Pump
- 3 Way Nozzle Bodies
- Fresh Water Rinse Tank
- Chemical Inductor Tank



AFS42C	42' with Hydraulic Centrifugal Pump
AFS52C	52' with Hydraulic Centrifugal Pump
AFS42GD	42' with Ground Drive Pump
AFS52GD	52' with Ground Drive Pump

# UTV/ATV PICKUP SKIDS & SPRAYERS

## WAKO ROADRUNNER75



**Gas Powered Features:**  
Honda Engine GX160 5.5HP W/Ace  
Centrifugal Pump

**Electric Features:**  
5.3GPM Remco Diaphragm Pump  
W/Pressure Switch

### ELECTRIC CAB CONTROLS



SCSO2420WP3

### Features: All of Wako RoadRunners Include

- 75 Gallon Ace Tank
- 15' EPDM Hose W/Reel
- Handwand
- Banjo Fittings
- Cab Access Control
- 30' Boomless Nozzle Kit
- Swivel Boom W/Boomless Nozzles

### Optional:

- Electronic Cab Controls
- 12', 18', 22' Steel Boom W/Dripless Nozzles
- Fire Fighter Kit

### FIRE FIGHTER KIT



ASRW075FKIT

**FULLY REPLACEABLE PARTS  
ALL AVAILABLE AT WAKO**





# WAKO BUILT SPRAYERS

## UTV/ATV, Pickup Skids & Sprayers

Wako can custom build a sprayer for your specific needs. Lots of sprayer options, too many to list. Call for price and availability.

### Skid Sprayer



**Sizes: 55-500 Gallon**  
Electric 12V  
5.3 GPM OR 7.0 GPM

5.5 HP GX 160 Honda W/Ace  
Centrifugal Pump

5.5 HP GX 160 Honda w/Hypro Silver

ASRW200PU	200 GAL
ASRW300PU	300 GAL
ASRW400PU	400 GAL
ASRW500PU	500 GAL GAS
ASRW500PUE	500 GAL ELECTRIC

### Skid Mount Fire Fighter



- Skid Mount
- High Pressure Spray Nozzle
- Honda Engine
- Aussie Fire Chief Pump
- Pond Strainer
- Electric Hose Reel

ASRW400FIRE	400 GAL
ASRW500FIRE	500 GAL

### 3PT Sprayer

**Sizes:**  
**55-500 Gallon**

**Boom & Boomless Nozzles**  
Add on options: Electric Shutoff,  
Boom Control, Choice of Pump

**Features:**

- Deluxe Tee Jet Hand Wand W/Adjustable Tip
- Manual or Electric Controls
- Pressure Gauge
- 50 1/2' EPDM Hose
- High Quality Valves/Fittings
- 4 Point Stand



CATEGORY 1: 55-110 GAL  
CATEGORY 2: 55-150 GAL  
CATEGORY 3: 200-400 GAL

PART#	GALLONS	CATEGORY
ASRW0553PT	55 GALLON	1
ASRW1103PT	110 GALLON	1
ASRW1503PT	150 GALLON	1 & 2
ASRW2003PT	200 GALLON	3 & 4
ASRW3003PT	300 GALLON	3 & 4
ASRW4003PT	400 GALLON	3 & 4

# WAKO BUILT SPRAYERS

## UTV/ATV, Pickup Skids & Sprayers

Wako can custom build a sprayer for your specific needs. Lots of sprayer options, too many to list. Call for price and availability.

### Mini-Mite Lawn & Garden Sprayer



Sizes:  
15-50 Gallon

HANDWAND INCLUDED

Optional:  
Boom or Boomless

- Premium Ace Tank w/Drain Plug
- Quality 12V ShurFlo Pump (1year warranty)
- Tee-Jet Handwands W/adjustable Spray Tips
- Banjo Fittings W/Micro-Viton valves
- Bypass Agitation System W/Pressure Gauge
- 15' of Premium 3/8" EPDM Hose
- Double Filtering-at Pump intake and at Nozzles
- 80" Coverage Boom or 240" coverage Boomless

ASRM1518HW	15 GAL HANDWAND
ASRM1518HWB	15 GAL HANDWAND & BOOM
ASRM2535BMLSS2	BOOMLESS
ASRM2535HW	HANDWAND
ASRM2535HWB	HANDWAND & BOOM

### NEW Mini-Mite Trailer Sprayer

Boom, 80" Swath, Dripless Nozzles,  
Handwand, Hose,  
3.5 GPM Pump



Size:  
25 Gallon

ASRM2535T

### Trailer Sprayer

Features: Sizes: 200-500 Gallon

- Heavy Duty Frame
- 11L-15 Farm Implement Tires
- Manual or Electronic Cab Controls
- Boomless Spray Nozzles
- Hose Reel with EPDM Hose

Pump Options:

- Electric 12V 5.3 GPM OR 7.0 GPM
- 5.5 HP GX 160 Honda W/Ace Centrifugal Pump
- 5.5 HP GX 160 Honda w/Hypro Silver 7 Roller Pump

Boom Options:

- 12', 18', 22'



Pictured:  
200 Gallon

## WAKO MANUFACTURED CATTLE MISTER

**COMING  
SOON**



# SKIDS & SADDLES

For many uses - Other options available.

## ELLIPTICAL SKID

PART#	DESCRIPTION
TAESP0300	Saddle & Skid 300gal Elliptical Tank
TAESP0400	Saddle & Skid 400gal Elliptical Tank
TAESP0500	Saddle & Skid 500gal Elliptical Tank
TAESP0750	Saddle & Skid 750gal Elliptical Tank
TAESP1000	Saddle & Skid 1000gal Elliptical Tank
TAESP1600	Saddle & Skid 1600gal Elliptical Tank



## BASIC SKID

PART#	DESCRIPTION
TAASK0055	Basic Skid 55gal App Tank
TAASK0110	Basic Skid 110gal App Tank
TAASK15032	Basic Skid 150gal App Tank
TAASK20032	Basic Skid 200gal App Tank
TAASK0300	Basic Skid 300gal App Tank
TAASK0400	Basic Skid 400gal App Tank



## PICKUP SKID

PART#	DESCRIPTION
TAASPA0055	PU Skid 55gal App Tank
TAASPA0110	PU Skid 110gal App Tank
TAASPA015032	PU Skid 150gal App Tank
TAASPA0200	PU Skid 200gal App Tank
TAASPA0300	PU Skid 300gal App Tank
TAASPA0400	PU Skid 400gal App Tank
TAASPA050048	PU Skid 500gal App Tank

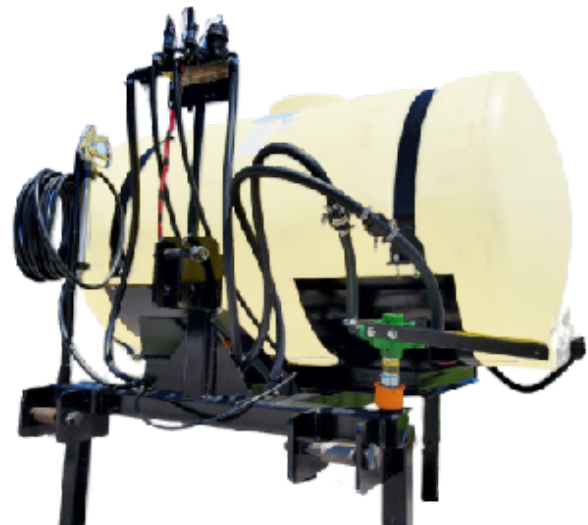

## 3-PT SKID ASSY

PART#	DESCRIPTION
TAAST0055	3-PT ASSY Skid 55gal App Tank
TAAST0110	3-PT ASSY SKid110gal App Tank
TAAST015032	3-PT ASSY Skid 150gal App Tank
TAAST050032	3-PT ASSY Skid 200gal App Tank
TAAST0300	3-PT ASSY Skid 300gal App Tank
TAAST04003	3-PT ASSY Skid 400gal App Tank
TAAST050042	3-PT ASSY Skid 500gal App Tank

# TANKS

**MORE SIZES IN STOCK OR  
AVAILABLE TO ORDER**

## HORIZONTAL LEG



Molded in baffles for reduced liquid surge.

Molded in tank legs.

Metal tie-down bands optional.

ITEM CODE	DESCRIPTION	Optional Bands
TAH0225	225 Gallon 38x49	2
TAH0310	325 Gallon 38x68	2
TAHE0300	340 Gallon Enduraplas Black	
TAHE0400	400 Gallon Enduraplas Black	
TAHC0500	500 Gallon 48x75 172 lb.	2
TAHE0500	550 Gallon Enduraplas Black	
TAHC0750	750 Gallon 48x107 246 lb.	3
TAHE800	800 Gallon Enduraplas Black	
TAHC1000	1000 Gallon 48x139 302 lb.	4
TAHE1000	1100 Gallon Enduraplas Black	
TAHE1200	1200 Gallon Enduraplas Black	
TAHE1400	1400 Gallon Enduraplas Black	
TAHE1600	1600 Gallon Enduraplas Black	
TAHC1650	1650 Gallon 62x139	4
TAHE2200	*2200 Gallon Enduraplas Black	
TAHE2500	*2500 Gallon Enduraplas Black	
TAHE3000	*3000 Gallon Enduraplas Black	
TAHE3200	*3200 Gallon Enduraplas Black	
TAHES0500	*Sump 550 Gallon Enduraplas Black	
TAHES1000	*Sump 1000 Gallon Enduraplas Black	
TAHES1200K	*Sump 1200 Gallon Enduraplas Black W/Frame	
TAHES1600	*Sump 1600 Gallon Enduraplas Black	
TAHES2200	*Sump 2200 Gallon Enduraplas Black	
TAHES2200K	*Sump 2200 Gallon Enduraplas Black W/Frame	
TAHES03000	*Sump 3000 Gallon Enduraplas Black	
TAHES3200	*Sump 3200 Gallon Enduraplas Black	
TAHEL1600	*Water Only 1600 Gallon Enduraplas Green	

**\* SPECIAL ORDER**

## APPLICATOR



This versatile tank can be used for a variety of applications.

Center sumped for complete drainage.  
Requires mounting saddles.

ITEM CODE	DESCRIPTION
TAA0055	55 Gallon 23x37
TAA0075	75 Gallon
TAA0110	110 Gallon 30x44 40 lb.
TAA015032	150 Gallon 32x52 48 lb.
TAA020032	200 Gallon 32x65 74 lb.
TAA0300	300 Gallon 38x69 90 lb.
TAA0400	400 Gallon 42x76 108 lb.
TAA050048	500 Gallon 48x74 130 lb.





# TANKS

\* SPECIAL ORDER

## VERTICAL



Two top-edge molded-in lugs for sure and safe tie down on 55 gal. and larger.

2" siphon outlet fitting standard

ITEM CODE	DESCRIPTION
TAVE00100	100 Gallon Enduraplas Black
TAVE00150	150 Gallon Enduraplas Black
TAVE00200	200 Gallon Enduraplas Black
TAV0200	210 Gallon 32" W X 69" H 54lb
TAV0300	300 Gallon 42" W X 59" H
TAVE00340	340 Gallon Enduraplas Black
TAV0550	550 Gallon 47" W X 77" H
TAVE00550	550 Gallon Enduraplas Black
TAV1100	1100 Gallon 87" W X 53" H
TAVE1000	1100 Gallon Enduraplas Black
TAV1300	1350 Gallon 84" W 69" H
TAVE1350	1350 Gallon Enduraplas Black
TAV1600	1650 Gallon 87" W X 65" H
TAVE1600	1650 Gallon Enduraplas Black
TAV2500	2500 Gallon 95" W X 91" H
TAVE2500	2500 Gallon Enduraplas Black
TAV3100	3000 Gallon 95" W X 109" H
TAVE3000	3000 Gallon Enduraplas Black
TAVE4000	*4000 Gallon Enduraplas Black
TAVE5000	*5000 Gallon Enduraplas Black
TAVE6011	*6011 Gallon Enduraplas Black
TAVE6250	*6250 Gallon Enduraplas Black
TAVEW1550	*Water Only 1550 Gallon Enduraplas Black
TAVEW1650	*Water Only 1650 Gallon Enduraplas Black
TAVEW3000	*Water Only 3000 Gallon Enduraplas Black

## ELLIPTICAL



Low profile for added visibility and easy reach filling. Bottom sumped for total drainage.

Requires mounting saddles.

ITEM CODE	DESCRIPTION	SIZE
TAE0300	300 Gallon	48" W X 30" H X 70" L / 115lb
TAE0400	400 Gallon	57" W X 35" H X 70" L / 140lb
TAE0500	500 Gallon	57" W X 36" H X 82" L / 160lb
TAE0750	750 Gallon	69" W X 42" H X 88" L / 231lb
TAE1000	1000 Gallon	78" W X 49" H X 90" L / 314lb
TAE1600	1600 Gallon	78" W X 49" H X 138" L / 420lb

## PCO TANKS



Compact design requires no saddles or support structures.

Ideal for ag, nursery, lawn care, pest and comm. turf sprayers.

ITEM	DESCRIPTION
TAP0030	30 Gallon 19" W X 20" H X 25" L 16lb
TAP0050	50 Gallon 19" W X 20" H X 38" L 22.5lb
TAP0100	100 Gallon 30" W X 26" H X 48" L 41.5lb
TAP0150	150 Gallon 36" W X 26" H X 48" L 63lb
TAP0200	200 Gallon 36" W X 35" H X 48" L 76lb

# TANKS

**MORE SIZES IN STOCK OR  
AVAILABLE TO ORDER**

## CONE TANKS

### INDUCTION



Item Code	Description	Gallons	Dimensions
TAC0015	TANK CONE 15gal	15	
TAC15STD	TANK STD F/15gal	15	19" W X 23" H
TAC0030	TANK CONE 30gal	30	24" W X 28" H
TAC0060	TANK CONE 55gal	55	24" W X 42" H
TAC00STD	TANK STAND	30 & 55	

## LARGE CONE TANKS



Item Code	Description	Gallons
*TACE2500	TANK CONE 2500 Gallon Enduraplas Black	2500
*TACE2500K	TANK CONE 2500 Gallon Enduraplas Black W/Stand	2500
*TACE3000	TANK CONE 3000 Gallon Enduraplas Black	3000
*TACE3000K	TANK CONE 3000 Gallon Enduraplas Black W/Stand	3000
*TACB300090	TANK CONE 3000 Gallon 15° Bottom	3000
*TACEF6000	6000 Gallon W/Frame	6000

**\*SPECIAL ORDER**

## STATIONARY TENDER TRAILERS

### STATIONARY



**\*SPECIAL ORDER**

### \*Sizes:

TWO 2500 = 5000  
TWO 3000 = 6000  
THREE 2500 = 7500  
THREE 3000 = 9000

## PULL TYPE TENDER TRAILERS

### Size:

**1000 Gallon**





# BULKHEADS

<p><b>TANK FITTING BULKHEAD ROUND</b></p>  <p>TAF034 3/4" TAF112 1-1/2" TAF114 1-1/4" TAF200 2" TAF300 3"</p>	<p><b>TANK FITTING BULKHEAD SQUARE</b></p>  <p>TAF050 1/2" TAF100 1"</p>	<p><b>TANK FITTING BULKHEAD FLANGED</b></p>  <p>TAF220F 2" TAF300F 3"</p>	<p><b>WE CARRY MANY FITTINGS, LIDS &amp; SUPPLIES FOR YOUR TANKS.</b></p>
<p><b>TANK GASKET BULKHEAD</b></p>  <p>TAFG034 1/2"-3/4" TAFG60404 1"-1.25" TAFG200 1-1/2"-2"</p>	<p><b>TANK FITTING BULKHEAD BOLT</b></p>  <p>TAFBF034 3/4"</p>	<p><b>TANK GASKET SS BULKHEAD</b></p>  <p>SS 3/4"</p>	<p><b>GASKET</b></p>  <p>TAFG034SSV 3/4"</p>
<p><b>SIGHT GAUGE ADD ON</b></p>  <p>TAWSIGHTGAUGE 3/4"</p>	<p><b>SIPHON TUBE BULKHEAD</b></p>  <p>TAF200S 2" TAF300S 3"</p>	<p><b>TANK FITTING SKINTIP WATERTITE</b></p>  <p>TAWS21</p>	
<p><b>AGITATOR TANK JET EXTENDER</b></p>  <p>SPAT34X 3/4"</p>	<p><b>AGITATOR TANK JET TEE</b></p>  <p>SPAT34 3/4"</p>	<p><b>AGITATOR TANK JET</b></p>  <p>SPAT10VH 3/4" X 3/4"</p>	

# TANK LIDS

**TANK LID VENT & RING**



TAL10525 8"  
TAL5478 LID ONLY 10"  
TAL10527 12"  
TAL10528 16"

**TANK RIM RIVETED RAVEN**



TALR5464 16"

**TANK LID BLUE SNAP IN VENT**



TAL63485 16"

**BLUE SNAP IN VENT ONLY**



TAL63539

**TANK LID VENTED**



TAL60002 8"

**HINGED LID VENTED**



TALV14761 16"

**TANK LID SPIN ON**



TAL10522 5"

**TANK RIM RIVETED SCREW ON**



TALR5479 10"

**TANK LID BREATHER ONLY**



FOR 8" & 12" LIDS  
TALB10520

**TANK LID INNER BREATHER**



TALB5469 FOR 16" LIDS

**TANK LID VENT ONLY**



TAL5478V 10"

**GASKET LID**



TAL60366 5"

**LANYARD FOR LIDS**

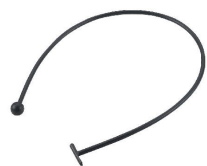

TALL10873 12" LENGTH  
TALL10534 16" LENGTH

**LANYARD SELF ANCHORING FOR LIDS**



TALL12460 12" LENGTH



# HYPRO ROLLER PUMPS

## 4 Roller Pump

Maximum flow:  
 9.1 gpm at 180 rpm  
 7.2 gpm at 2600 rpm  
 Maximum Pressure:  
 100 psi continuous operation  
 150 psi intermittent operation  
 Max. speed: 2600 rpm  
 Shaft size: 5/8" solid  
 Port size: 3/4" NPT

## 6 Roller Pump

Max. flow:  
 9.7 gpm at 540 rpm  
 18.2 gpm at 1000 rpm  
 21.8 gpm at 1200 rpm  
 Max. Pressure:  
 100 psi continuous operation  
 300 psi intermittent operation  
 Shaft size: 5/8" solid  
 Port size: 3/4" NPT

## 7 Roller Pump

14.2 gpm at 540 rpm  
 22.1 gpm at 800 rpm  
 100 psi continuous operation  
 200 psi intermittent operation  
 Shaft size: 15/16"  
 Port size: 3/4" NPT

## 8 Roller Pump

12 gpm at 540 rpm  
 22.5 gpm at 1000 rpm  
 100 psi continuous operation  
 300 psi intermittent operation  
 Shaft size: 15/16"  
 Port size: 3/4" NPT

### HYPRO 4 ROLLER CAST IRON



SPMHXL4101C

### HYPRO 4 ROLLER SILVER SERIES



SPMHXL4101

### HYPRO 6 ROLLER SILVER NO COUPLER



SPMHXL6500

### HYPRO 6 ROLLER SILVER REVERSED



SPMHXL6500-R

### HYPRO 6 ROLLER CAST IRON



SPMHXL6500C

### HYPRO 6 ROLLER CAST IRON REVERSED



SPMHXL6500C-R

### HYPRO 7 ROLLER SILVER NO COUPLER



SPMHXL7700

### HYPRO 7 ROLLER SILVER REVERSED



SPMHXL7700-R

### HYPRO 7 ROLLER CAST IRON NO COUPLER



SPMHXL7700C

### HYPRO 7 ROLLER CAST NO COUPLER REVERSED



SPMHXL7700C-R

### HYPRO 8 ROLLER CAST IRON NO COUPLER



SPMHXL7560C

### HYPRO 8 ROLLER SILVER NO COUPLER



SPMHXL7560

# ACE ROLLER PUMPS

ACE 6 ROLLER  
CAST IRON



SPMHA600C

ACE 6 ROLLER  
CAST IRON REVERSED



SPMHA600C-R

ACE 8 ROLLER  
CAST



SPMHA800C

ACE 8 ROLLER  
REVERSED



SPMHA800C-R

# CENTRIFUGAL PUMPS

ACE PUMP ONLY  
POLY 5/8"  
CENTRIFUGAL



SPMAGE75LE

ACE PUMP ONLY  
POLY 3/4"  
CENTRIFUGAL



SPMAGE85LE

ACE CAST IRON  
CENTRIFUGAL 3/4" KEYED



SPMAGE660

# HYDRAULIC CENTRIFUGAL PUMPS

HYDRAULIC CENTRIFUGAL  
INLET - OUTLET



SPMH9303

1-1/2" X 1-1/4"

HYDRAULIC CENTRIFUGAL  
INLET - OUTLET

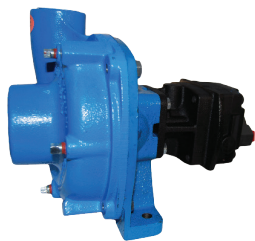

SPMH9304

2" X 1-1/2"

JOHN BLUE 150 SERIES  
HYDRAULIC CENTRIFUGAL  
INLET - OUTLET



SPMLCS150HYR 1-1/2" X 1-1/4"



# QUICK COUPLERS

**SNAP HITCH PUMP  
540 COUPLER  
1-3/8" 6T  
FORGED**



SPMH132112 **5/8"**  
SPMH132107F **15/16"**

**QUICK COUPLER  
540/1000  
STEEL**



SPMH132077 **5/8"**  
SPMH132076 **15/16"**

**QUICK COUPLER  
CAST**



SPMH132113 **15/16"**  
SPMH132107 **1-3/8"**

## PUMP REPAIR KITS & SUPPLIES



Item Code	Description
SPMHXRS0390	PUMP HYP 4R SILV KIT W/S ROLL
SPMHXR34300380	PUMPR HYP 6R RPR KIT SUPER ROL
SPMHXR20010	PUMPR HYP 6R SILV BEARING
SPMHXR2112	PUMPR HYP 7R SILV SEAL
SPMHXRS0381	PUMPR HYP 7/8R SILV RPR W/S RO
SPMHXR0167	PUMP REPAIR KIT 8-ROLLER POLY
SPMHXR04019100	PUMPC HYP 9303 IMPELLER ONLY
SPMHXR0589	KIT PUMP REPAIR 9303 HYD DYN
SPMHXR0748	KIT PUMP HYD 9303 SEAL REPAIR
SPMHXR0332	KIT PUMP REPAIR 9303 HYD CYN
SPMHA600-RK	ACE 6 ROLLER REPAIR KIT
SPHMHA800RK	ACE 8 ROLLER REPAIR KIT
SPMARKGE75	REPAIR KIT FOR ACE GE75 POLY PUMP
SPMARKGE85	REPAIR KIT FOR ACE GE85 POLY PUMP
SPMHXR34300380	REPR KIT SUPER ROLLER PMP R HYPRO 6 ROLR,
SPMAGE2675	IMPELLOR FOR ACE POLY PUMP
SPMAGE2685	IMPELLER FOR ACE POLY PUMP
SPMAGE26HYD	IMPELLOR FOR FMC-HYD-204 VALOX
SPMARKBAC75HYDL	REPAIR KIT ACE HYD PUMP
SPMARKFMC	ACE KIT REPR FMC SERIES PUMPS
SPMARKFMC150	PUMP ACE KIT REPAIR F/FMC-150
SPMARKFMC304	REPAIR KIT ACE FMC HYD PUMPS
SPMARKFMCSC150	ACE150 SERIES SILICON CARBID
SPMARKFMCSPRO5	ACE FMC SERIES PROS SEAL
SPMARKHYD300	REPAIR KIT ACE HYD 304 MOTORS

**MANY MORE REPAIR PARTS IN STOCK.**

# SPIDERS

**SPIDER**



SPL050 **L050**

**SPIDER**



SPL075 **L075**  
SPL095 **L095**  
SPL100 **L100**

# LOVE JOYS

**LOVE JOY**



SPL10075 **L100 X 3/4"**

**LOVE JOY**



SPL10100 **L100 X 1"**  
SPL10875 **L100 X 7/8"**  
SPL5625 **L050 X 5/8"**  
SPL7750 **L075 X 3/4"**  
SPL91000 **L095 X 1"**  
SPL9166 **L095 X 1-1/16"**  
SPL9625 **L095 X 5/8"**  
SPL9750 **L095 X 3/4"**  
SPL99375 **L095 X 15/16"**

**TORQUE BAR  
FOR ROLLER PUMPS**



SPMBAR

# ELECTRIC PUMPS AND REPAIRS

**2088 12V, 3.5GPM  
SHURFLO PUMP**



PART# SMT2088

**2088 115V, 3GPM  
SHURFLO PUMP  
W/CORD**



PART# SMT2088115

Item Code	Replacement Parts
SMT2088C	PUMP 2088 SWITCH ONLY
SMT2088F1212E	PUMP 2088 HB90 1/2" FPT X 1/2"
SMT2088F1212S	PUMP 2088 STHB 1/2" FPT X 1/2" HB
SMT2088F38S	PUMPT 2088 HB ST 1/2" FPT S X 3/8"
SMT2088H	PUMP 2088 HOUSING
SMT2088V	PUMP 2088 VALVE KIT
SMT2088F38	HB90 1/2"FPT X 3/8"
SHBBSW12	1/2" BRASS HOSE BARB

**5500 12V,  
5.3GPM W/  
PRESSURE SWITCH**



PART# SMT5503ED

**5500 12V,  
5.3GPM W/O  
PRESSURE SWITCH**



PART# SMT5503EE

Item Code	Replacement Parts
SMT5312904	LOWER HOUSING KIT FOR 5503
SMT53132	PUMP 5503 VITON VALVE KIT
SMT5503H	PUMP 5503 UPPER HOUSING W/BYPASS
SMT5503HS	PUMP 5503 UPPER HOUSING W/PRES SWITCH
SMT5503SW	PUMP 5503 SWITCH 12V
SMT500312MP	PUMP 5503 FITTING 1/2" MIP STRGHT
SMT5503E	PUMP 5503 FITTING 3/4" ELBOW
SMT5503E12	PUMP 5503 FITTING 1/2" ELBOW S
SMT5503E38	PUMP 5503 FITTING 3/8" ELBOW
SMT5503S	PMP 5503 FITTING 3/4" STRGHT
SMT5503S12	PMP 5503 FITTING 1/2" STRGHT
SMT5503S38	PMP 5503 FITTING 3/8" STRGHT

**12V 7.0GPM  
VALLEY**



PART# SMT7000

**12V 7.0 FOR  
DELAVAN QUICK  
TACH**



PART# SMT7870

**JOHN BLUE RHEOSTAT SWITCH  
12V SPEED CONTROLLER**

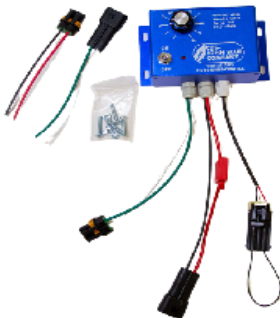

PART# SMTAKSC35-200



**20'  
EXTENTION**

PART# SMTAKSCP-031

**8000 12V, 1.8GPM  
SHURFLO**

PART# SMT8000



Item Code	Description
SMT8000B	PMP 8000 HOUSING W/ SWITCH
SMT8000S	PMP 8000 PRSS SWITCH KIT





# PUMPS

## FIRE CHIEF HONDA 5.5HP

*Aussie Pumps*

- MAX FLOW 100 GPM
- MAX PRESSURE 107 PSI
- 5 YEAR PUMP WARRANTY
- 3 YEAR ENGINE WARRANTY



ASREAPAC09

## Aussie Pump Repair Kit



ASREACPPA004

## JOHN BLUE NGP6055 GROUND DRIVE 21.0 SINGLE PISTON - DOUBLE ACTING

- MAX FLOW 21 GPM
- MAX PRESSURE 120 PSI
- MAX SPEED 450 RPM
- 1-1/2" OUTLET

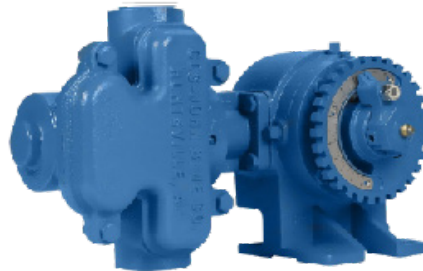

SPML6055

## JOHN BLUE 6055 Repair Kit



SPML115788

## SHURFLO 12V INLINE PORTABLE CHEMICAL TRANSFER CADDY PUMP

- MAX FLOW 10 GPM
- MAX PRESSURE 15 PSI
- 1" INLET - OUTLET

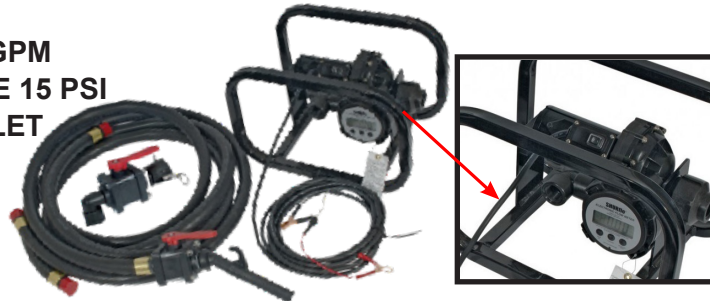

SPMHSF1100PTS

## Hypro Rocker Tote Switch



SML94747

## TOTE POLY BUTTRESS W/GASKET



2" MNPT X 2" BTRSS  
SPFT137C

## TOTE POLY BUTTRESS ADAPTOR W/ GASKET



2" BTRSS X 2" CAMLOCK  
SPFT283

## TOTE POLY BUTTRESS CAP



SPFT60CAP

60 MM

## TOTE CAM VALVE W/ COLLAR THREAD



SVABCF60  
SVABCF75

60 MM  
75 MM

# LIQUID FERTILIZER PUMPS



Liquid Fertilizer  
Pump Repair  
Parts available  
in store.

**BANJO 2" CAST IRON HONDA 5HP  
ELECTRIC START**



SPM200I5H

**BANJO IRON  
PUMP ONLY**



SPM200PI  
SPM300POI

2"  
3"

**BANJO 2" POLY HONDA 5HP ENGINE**



SPM200P5H

**BANJO 2" WET SEAL POLY HONDA 5.5HP**

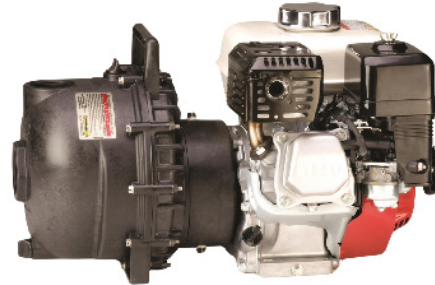

SPM200PH5W

**\*BANJO 2" WET SEAL IRON HONDA 5.5HP**



SPM201PIH5W

**BANJO 2" POLY 5.5 HONDA  
ELECTRIC START**



SPM200PH5E

**\*BANJO 3" WET SEAL IRON HONDA 13HP**



SPM301PIH13W

**BANJO 3" IRON HONDA 8HP ELECTRIC START**



SPM300IH-8



# LIQUID FERTILIZER PUMPS

## HYPRO®

Liquid Fertilizer Pump Repair Parts available in store.

HYPRO 2" POLY 6.5HP POWER PRO



SPMH1542P-65SP

HYPRO PUMP ONLY



SPM200PO  
SPM300P

2"  
3"

HYPRO 2" POLY 6.5HP ELECTRIC START



SPMH1542ELEC

HYPRO 2" POLY 6.5HP POWER PRO



SPM1542P-65SP

PULL START

HYPRO 3" POLY 13HP ELECTRIC



SPMH1543ELEC

HYPRO 3" POLY 13HP POWER PRO



SPM1543P-130SP

# JOHN BLUE LIQUID FERTILIZER PUMPS

JOHN BLUE 2" CAST IRON CENTRIFUGAL HONDA GX160 5HP

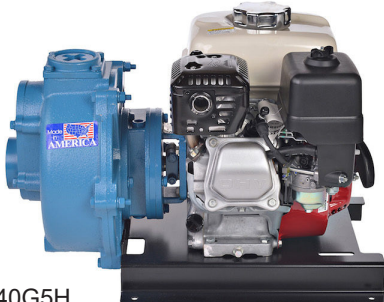

SPML3240G5H

JOHN BLUE 3" CAST IRON CENTRIFUGAL HONDA GX390 13HP



SPML3350G13H

## ENGINES

**ENGINE HONDA GX100 3HP  
5/8 KEYED SHAFT**



ENG3HP

**LIMITED/  
DISCONTINUED**

**HONDA ENGINE GX160 5.5HP  
3/4 KEYED SHAFT**



ENGE5.5HP

**ELECTRIC START  
& PULL**

**HONDA ENGINE GX 390 13HP  
1" THREAD SHAFT**

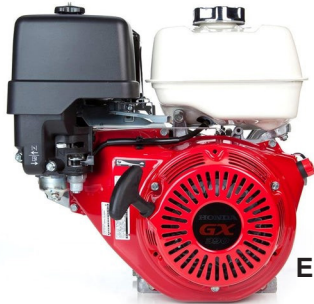

ENGH13HP

**ELECTRIC START  
& PULL**

**HONDA ENGINE GX270 9HP  
1" THREADED SHAFT**



ENGH9HP

**ELECTRIC START  
& PULL**

**HONDA ENGINE GX120 4HP 3/4 KEYED**



ENGH4HP

**LIMITED/  
DISCONTINUED**

**HONDA ENGINE GX160 5.5HP  
THREAD SHAFT**



ENGH5.5HP

**HONDA ENGINE GX160 5.0HP**



ENGH5HPGC

**LIMITED/  
DISCONTINUED**

**HONDA ENGINE 6:1 RED GX160 5.5HP**



ENGH5HP



# ENGINE REPAIRS

**HYPRO  
6.5HP AIR FILTER**



ENG25450036

**HONDA ENGINE 9HP  
AIR FILTER**



ENGRAIRFILTER9

**AIR FILTER  
FOR 13HP**



ENG25450186

**HONDA ENGINE  
GX160 AIR FILTER**



ENGRAIRFILTER

**HYPRO 6.5HP  
RECOIL ASM**



ENG25450042

**HONDA ENGINE  
RECOIL ASM METAL**



ENGRRECH-M

**HONDA KEY FITS  
TO GX390**



ENGHKEY

**HONDA ENGINE  
SWITCH ON OFF**



ENGRSWITCHONOFF

**HONDA ENGINEMUFFLER GX160**



ENGRMUFFLER

**HYPRO 6.5 AIR CLEANER COVER**



ENG25450033

**HYPRO 6.5 FUEL CAP**



ENG25450045

# THREADED BALL VALVES

**FULL PORT 4 BOLT**



SVAB050 1/2" FPT  
 SVAB075 3/4" FPT  
 SVAB100FP 1" FPT  
 SVAB125FP 1-1/4" FPT  
 SVAB150 1-1/2" FPT

**FULL PORT 6 BOLT**



SVAB200FP 2" FPT  
 SVAB300FP 3" FPT  
 SVAB400FP 4" FPT

**STUBBY**



2" MPT X 2" FPT  
 SVAB200STBY

**ANGLE FP W/NOZZLE**



SVABA200FP 2" FPT

**FULL PORT UNION**



SVAB050U 1/2" FPT  
 SVAB075U 3/4" FPT  
 SVAB100U 1" FPT  
 SVAB125U 1-1/4" FPT  
 SVAB150U 1-1/2" FPT  
 SVAB200U 2" FPT

**BUNA**



SVAB050B 1/2" FPT

**REPLACEMENT HANDLES FOR BALL VALVES**



SVAB10153 1"  
 SVAB20153 1-1/2"  
 SVAB25153 2" & 3"

**BALL VALVE KIT FOR 2" & 3"**



SVAB10200 1"  
 SVAB25200 2"  
 SVAB35200 3"

# FLANGED BALL VALVES

**FLANGED 4 BOLT**



SVAB100F 1"  
 SVAB200F 1-1/2"  
 SVAB200FFP 2"

**3" FLANGED FULL PORT 6 BOLT**



SVABMV300CF 3"

**STUBBY FLANGED**



SVAB220CF 2"

**LOCKING STUBBY STAINLESS STEEL**



SVABL200F 2"  
 SVABL300F 3"

**BOTTOM LOAD FULL PORT FLANGED**



SVABMV100BL 1"

**MOUNTING BRACKET FOR BALL VALVES FITS 2" & 3"**



SVABV25271 90°  
 SVABV25270 STRAIGHT

**FLNG GASKET**



SCLG100 1"  
 SCLG200 1-1/2"  
 SCLG220 2"  
 SCLG300 3"  
 SCLG220V VITON 2"  
 SCLG300V VITON 3"

**CLAMPS**



SFCC100 1"  
 SFCC200 1-1/2"  
 SFCC220 2"  
 SFCC300 3"

ALSO ON PAGE: 29



# FITTINGS

**WAKO HAS A HUGE INVENTORY OF STEEL, POLY & PVC FITTINGS.**



**WE CAN SET UP PLUMBING FOR ANY SPRAYER!**

**SIZES 1/8" - 3"**

## METAL PIPE FITTINGS



### BELL REDUCER

SCH 40 STEEL = NPB  
SCH 80 STEEL = NQB



### BUSHING REDUCER

SCH 40 STEEL = NPB  
SCH 80 STEEL = NQB



### COUPLER

SCH 40 STEEL = NPC  
SCH 80 STEEL = NQC



### 90° ELBOW

SCH 40 STEEL = NPE  
SCH 80 STEEL = NQE



### 90° STREET ELBOW

SCH 40 STEEL = NPS  
SCH 80 STEEL = NQS



### 45° ELBOW

SCH 40 STEEL = NPL  
SCH 80 STEEL = NQL



### TEE

SCH 40 STEEL = NPT  
SCH 80 STEEL = NQT



### NIPPLE

SCH 40 STEEL = NPN  
SCH 80 STEEL = NQN



### CROSS

SCH 40 STEEL = NPX  
SCH 80 STEEL = NQX



### UNION

SCH 40 STEEL = NPU  
SCH 80 STEEL = NQU



### SQUARE HEAD PLUG

SCH 40 STEEL = NPP  
SCH 80 STEEL = NQP

**CALL for a complete listing.**

**FROM 1/8" UP TO 4"**

**SCHEDULE 40 & 80 STEEL - ALUMINUM - GALVANIZED - STAINLESS STEEL**

# POLY FITTINGS

## POLY NIPPLE LONG



SPFTN344	3/4" MPT X 4"
SPFTN144	1" MPT X 4"
SPFTN1144	1-1/4" MPT X 4"
SPFTN1124	1-1/2" MPT X 4"
SPFTN242	2" MPT X 4"
SPFTN262	2" MPT X 6"
SPFTN363	3" MPT X 6"

## POLY NIPPLE CLOSE



SPFTN022	1/8" MPT
SPFTN044	1/4" MPT
SPFTN066	3/8" MPT
SPFTN088	1/2" MPT
SPFTN212	3/4" MPT
SPFTN616	1" MPT
SPFTN020	1-1/4" MPT
SPFTN424	1-1/2" MPT
SPFTN232	2" MPT
SPFTN343	3" MPT
SPFTNC400	4" MPT

## POLY REDUCER NIPPLE

MPT X MPT



SPFTRN64	3/8" X 1/4"
SPFTRN84	1/2" X 1/4"
SPFTRN86	1/2" X 3/8"
SPFTRN26	3/4" X 3/8"
SPFTRN28	3/4" X 1/2"
SPFTRN12	1" X 3/4"
SPFTRN20	1-1/4" X 3/4"
SPFTRN16	1-1/4" X 1"
SPFTRN2420	1-1/2" X 1-1/4"
SPFTRN2025	2" X 1-1/4"
SPFTRN3224	2" X 1-1/2"
SPFTRN32	3" X 2"

## POLY TEE ALL FPT



SPFB1400	1/4"
SPFB1600	3/8"
SPFB1200	1/2"
SPFB3400	3/4"
SPFB1100	1"
SPFB1140	1-1/4"
SPFB1120	1-1/2"
SPFB2000	2"
SPFB3000	3"

## POLY TEE ALL FPT W/ GAUGE PORT



SPFBG1614	1/2" W/1/4" GA
SPFBG3414	3/4" W/1/4" GA
SPFBG1014	1" W/1/4" GA
SPFBG2014	1-1/4" W/1/4" GA
SPFBG3214	2" W/1/4" GA

## POLY COUPLER PIPE



SPFC014	1/4"
SPFC038	3/8"
SPFC050	1/2"
SPFC075	3/4"
SPFC100	1"
SPFC125	1-1/4"
SPFC150	1-1/2"
SPFC200	2"
SPFC300	3"

## POLY REDUCER COUPLER

FPT X FPT



SPFCR15100	1-1/4" X 1-1/4"
SPFCR15125	1-1/2" X 1"
SPFCR20100	2" X 1"
SPFCR20125	2" X 1-1/4"
SPFCR20150	2" X 1-1/2"
SPFCR30200	3" X 2"

## POLY EL FPT X FPT



SPFEL44	1/4" X 1/4"
SPFEL212	1/2" X 1/2"
SPFEL434	3/4" X 3/4"
SPFEL111	1" X 1"
SPFEL114	1-1/4" X 1-1/4"
SPFEL112	1-1/2" X 1-1/2"
SPFEL200	2" X 2"
SPFEL300	3" X 3"

## POLY HEX CAP



SPFHC4	1/4"
SPFHC6	3/8"
SPFHC8	1/2"
SPFHC12	3/4"
SPFHC16	1"
SPFHC125	1-1/4"
SPFHC24	1-1/2"
SPFHC32	2"
SPFHC42	3"

## POLY ST EL 90°

MPT X FPT



SPFS414	1/4" X 1/4"
SPFS616	3/8" X 3/8"
SPFS212	1/2" X 1/2"
SPFS334	3/4" X 3/4"
SPFS111	1" X 1"
SPFS114	1-1/4" X 1-1/4"
SPFS1112	1-1/2" X 1"
SPFS112	1-1/2" X 1-1/2"
SPFS122	2" X 2"
SPFS4848	3" X 3"

## POLY ST EL 45°

MPT X FPT



SPFSE414	1/4" X 1/4"
SPFSE12	1/2" X 1/2"
SPFSE334	3/4" X 3/4"
SPFSE1	1" X 1"
SPFSE114	1-1/4" X 1-1/4"
SPFSE112	1-1/2" X 1-1/2"
SPFSE2	2" X 2"
SPFSE3	3" X 3"

## POLY HEX PLUG



SPFTP404	1/4" MPT
SPFTP406	3/8" MPT
SPFTP408	1/2" MPT
SPFTP402	3/4" MPT
SPFTP401	1" MPT
SPFTP400	1-1/4" MPT
SPFTP024	1-1/2" MPT
SPFTP403	2" MPT
SPFTP4048	3" MPT





# POLY FITTINGS

## POLY REDUCER BUSHING MPT X FPT



SPFT0309	1/4" X 1/8"	SPFT0208	1-1/4" X 1/2"
SPFT0313	3/8" X 1/8"	SPFT0316	1-1/4" X 3/4"
SPFT0301	3/8" X 1/4"	SPFT0305	1-1/4" X 1"
SPFT0314	1/2" X 1/4"	SPFT0317	1-1/2" X 3/4"
SPFT0302	1/2" X 3/8"	SPFT0318	1-1/2" X 1"
SPFT0310	3/4" X 1/8"	SPFT0306	1-1/2" X 1-1/4"
SPFT0311	3/4" X 1/4"	SPFT037C	2" X 3/4"
SPFT0312	3/4" X 3/8"	SPFT037B	2" X 1"
SPFT0303	3/4" X 1/2"	SPFT037A	2" X 1-1/4"
SPFT0315	1" X 1/2"	SPFT0307	2" X 1-1/2"
SPFT0304	1" X 3/4"	SPFT0319	3" X 2"
		SPFT0400	4" X 3"

## POLY CROSS



SPFX034	3/4"
SPFX100	1"
SPFX125	1-1/4"
SPFX150	1-1/2"
SPFX200	2"

## POLY CROSS W/GAUGE PORT



1/2" WITH 1/4" GAUGE PORT  
SPFX01214

## TOTE POLY BUTTRESS W/GASKET



2" MNPT X 2" BTRSS  
SPFT137C

## TOTE POLY BUTTRESS ADAPTOR W/ GASKET



2" BTRSS X 2" CAMLOCK  
SPFT283

## TOTE POLY BUTTRESS CAP



60MM  
SPFT60CAP

## TOTE CAM VALVE W/ COLLAR THREAD



SVABCF60 60 MM  
SVABCF75 75 MM

ALSO ON PAGE: 16

# POLY HOSE BARB FITTINGS

## POLY HOSE BARB REDUCER HB X HB



SHJ80106	3/8" X 5/8"
SHJ8086	1/2" X 3/8"
SHJ80108	1/2" X 5/8"

## POLY HOSE BARB JOINER



SHJ7022	1/8"
SHJ7044	1/4"
SHJ7066	3/8"
SHJ7088	1/2"
SHJ71010	5/8"
SHJ71212	3/4"
SHJ71616	1"
SHJ72020	1-1/4"
SHJ72424	1-1/2"
SHJ73232	2"
SHJ73000	3"

## POLY EL HOSE BARB FPT EL X HB



3/4" FPT X 3/4" HB  
SHB0434

# POLY HOSE BARB FITTINGS



**POLY STRAIGHT HOSE BARB**  
MPT X HB

SHB1024	1/8" X 1/4"
SHB1026	1/8" X 3/8"
SHB1044	1/4" X 1/4"
SHB1046	1/4" X 3/8"
SHB1048	1/4" X 1/2"
SHB1064	3/8" X 1/4"
SHB1066	3/8" X 3/8"
SHB1068	3/8" X 1/2"
SHB1084	1/2" X 1/4"
SHB1086	1/2" X 3/8"

SHB1088	1/2" X 1/2"
SHB10810	1/2" X 5/8"
SHB10812	1/2" X 3/4"
SHB10816	1/2" X 1"
SHB10126	3/4" X 3/8"
SHB10128	3/4" X 1/2"
SHB10210	3/4" X 5/8"
SHB10212	3/4" X 3/4"
SHB10216	3/4" X 1"

SHB10612	1" X 3/4"
SHB10616	1" X 1"
SHB10620	1" X 1-1/4"
SHB10012	1-1/4" X 3/4"
SHB10016	1-1/4" X 1"
SHB10020	1-1/4" X 1-1/4"
SHB10024	1-1/4" X 1-1/2"
SHB10420	1-1/2" X 1-1/4"
SHB10424	1-1/2" X 1-1/2"
SHB10224	2" X 1-1/2"
SHB10232	2" X 2"
SHBH300	3" X 3"

**POLY Y HOSE BARB**  
HB



SHBY666	3/8"
SHBY888	1/2"



**POLY EL HOSE BARB**  
MPT X HB

SHB2044	1/4" X 1/4"
SHB2046	1/4" X 3/8"
SHB2048	1/4" X 1/2"
SHB2064	3/8" X 1/4"
SHB2066	3/8" X 3/8"
SHB2068	3/8" X 1/2"
SHB2084	1/2" X 1/4"
SHB2086	1/2" X 3/8"
SHB2088	1/2" X 1/2"
SHB20810	1/2" X 5/8"

SHB20812	1/2" X 3/4"
SHB20816	1/2" X 1"
SHB20126	3/4" X 3/8"
SHB20128	3/4" X 1/2"
SHB20121	3/4" X 5/8"
SHB20212	3/4" X 3/4"
SHB20216	3/4" X 1"
SHB20612	1" X 3/4"
SHB20616	1" X 1"
SHB20162	1" X 1-1/4"

SHB20012	1-1/4" X 3/4"
SHB20016	1-1/4" X 1"
SHB20020	1-1/4" X 1-1/4"
SHB20024	1-1/4" X 1-1/2"
SHB20242	1-1/2" X 1-1/4"
SHB20424	1-1/2" X 1-1/2"
SHB20224	2" X 1-1/2"
SHB20232	2" X 2"

**POLY EL HOSE BARB**  
HB X HB



SHB2066T	3/8" X 3/8"
SHB2088T	1/2" X 1/2"
SHB2012T	3/4" X 3/4"
SHB2016T	1" X 1"
SHB2020T	1-1/4" X 1-1/4"
SHB2024T	1-1/2" X 1-1/2"
SHB2032T	2" X 2"

**POLY TEE HOSE BARB**  
T ALL HB



SHB9444	1/4"
SHB9666	3/8"
SHB9888	1/2"
SHB91010	5/8"
SHB91212	3/4"
SHB91616	1"
SHB92020	1-1/4"
SHB92424	1-1/2"
SHB93232	2"

**POLY TEE HOSE BARB**  
MPT X HB X HB



SHB3444	1/4" X 1/4" X 1/4"
SHB3212	3/4" X 3/4" X 3/4"
SHB3616	3/4" X 1" X 1"
SHB3866	1/2" X 3/8" X 3/8"
SHB3888	1/2" X 1/2" X 1/2"

**POLY TEE HOSE BARB REDUCER**  
HB



SHB9688	3/8" X 1/2" X 1/2"
SHB91288	3/4" X 1/2" X 1/2"

**POLY TEE HOSE BARB**  
FPT X HB X HB



SHBF1212	3/4" X 3/4" X 3/4"
----------	--------------------



# CAMLOCK FITTINGS

**A**      **FPT X MCL**



SCL075A	3/4"
SCL100A	1"
SCL125A	1-1/4"
SCL150A	1-1/2"
SCL200A	2"
SCL300A	3"
SCL400A	4"

**A90°**  
**90° FPT X FCL**



SCL150A9	1-1/2"
SCL200A9	2"

**B**      **MPT X FCL**



SCL075B	3/4"
SCL100B	1"
SCL125B	1-1/4"
SCL150B	1-1/2"
SCL200B	2"
SCL300B	3"
SCL400B	4"

**B REDUCER**  
**1/2" MPT X 3/4" FCL**



SCL075B12

**C**      **HB X FCL**



SCL075C	3/4"
SCL100C	1"
SCL125C	1-1/4"
SCL150C	1-1/2"
SCL200C	2"
SCL300C	3"
SCL400C	4"

**C90°**  
**90° HB X FCL**



SCL150C9	1-1/2"
SCL200C9	2"

**CAP**  
**DUST CAP**



SCL075CA	3/4"
SCL100CA	1" & 1-1/4"
SCL150CA	1-1/2"
SCL200CA	2"
SCL300CA	3"
SCL400CA	4"

**D**      **FPT X FCL**



SCL075D	3/4"
SCL100D	1"
SCL125D	1-1/4"
SCL150D	1-1/2"
SCL200D	2"
SCL300D	3"
SCL400D	4"

**D90°**  
**90° FPT X FCL**



SCL150D9	1-1/2"
SCL200D9	2"

**E**      **HB X MCL**



SCL075E	3/4"
SCL100E	1"
SCL125E	1-1/4"
SCL150E	1-1/2"
SCL200E	2"
SCL300E	3"
SCL400E	4"

**F**      **MPT X MCL**



SCL075F	3/4"
SCL100F	1"
SCL125F	1-1/4"
SCL150F	1-1/2"
SCL200F	2"
SCL300F	3"
SCL400F	4"

**FF**      **MCL**



SCL200FF	2" X 2"
SCL300FF	3" X 3"

# CAMLOCK FITTINGS

**F REDUCER**  
3" MPT X 2" MCL



SCL300MP200F

**F90°**  
90° MPT X MCL



SCL150F9      1-1/2"  
SCL200F9      2"

**G GASKET**



SCL075G	3/4"
SCL100G	1"
SCL150G	1-1/2"
SCL200G	2"
SCL200GX	2" HD
SCL300G	3"
SCL300GX	3" HD
SCL400G	4"
SCL400GX	4" HD

**K CAM ARM & RING**



SCL150K      1-1/2"  
SCL300K      3"

**MCL MCL REDUCER**



SCL300F200F      3" X 2"

**P PINS FOR CAMLOCKS**



SCL150P      1-1/2"  
SCL300P      3"

**PLUG DUST PLUG**



SCL075PL	3/4"
SCL100PL	1"
SCL100PL	1-1/4"
SCL150PL	1-1/2"
SCL200PL	2"
SCL300PL	3"
SCL400PL	4"

**PLUG PLUG WITH HANDLE**



SCL200PLH      2"  
SCL300PLH      3"

**R RINGS FOR CAMLOCK ARMS**



SCL150R      1-1/2"-2"

**VENTURI HV200 THREADED**



SPFHV200      2" MPT

Camlock Legend		
FPT	=	Female Pipe Thread
MPT	=	Male Pipe Thread
HB	=	Hose Barb
FCL	=	Female Coupler
MCL	=	Male Coupler (Adapter)

**Also available in:**  
Aluminum, Brass, Ductile Iron,  
Stainless Steel, Heavy Duty  
and Cast Aluminum



# POLY FLANGE FITTINGS

**A**  
**FLANGE X  
 MALE CAM ADAPTER**



SFCM100A 1"  
 SFCM200A 1-1/2"  
 SFCM220A 2"  
 SFCM300A 3"

**BRB**  
**FLANGE X  
 HOSE BARB**



SFCM100BRB 1" X 1"  
 SFCM200BRB 1-1/2" X 1-1/2"  
 SFCM220BRB 2" X 2"  
 SFCM300BRB 3" X 3"

**BRB REDUCER**  
**FLANGE X  
 HOSE BARB**



SFCM100075BRB 1" X 3/4"  
 SFCM200100BRB 1-1/2" X 1"  
 SFCM200125BRB 1-1/2" X 1-1/4"  
 SFCM200150BRB 1-1/2" X 1-1/2"  
 SFCM220150BRB 2" X 1-1/2"  
 SFCM300220BRB 3" X 2"

**BRB 90°**  
**FLANGE X HB 90°**



SFCM100BRB90 1" X 1"  
 SFCM220BRB90 2" X 2"  
 SFCM300BRB90 3" X 3"

**BRB 90°  
 REDUCER**  
**FLANGE X HB 90°**



SFCM100075BRB90 1" X 3/4"  
 SFCM200100BRB90 1-1/2" X 1"  
 SFCM200125BRB90 1-1/2" X 1-1/4"  
 SFCM200150BRB90 1-1/2" X 1-1/2"  
 SFCM220150BRB90 2" X 1-1/2"  
 SFCM300220BRB90 3" X 2"

**HB 45°**  
**45° HB DEG**



3" FLNG X 3" HB 45 DEG  
 SFCM300BRB45

**HBT**  
**FLANGE X HB TEE**



SFCM100100HBT 1" X 1"  
 SFCM220200HBT 2" X 2"  
 SFCM300300HBT 3" X 3"

**CPG45**  
**FLANGE X  
 FLANGE 45°**



SFCM100CPG45 1"  
 SFCM220CPG45 2"  
 SFCM300CPG45 3"

**CPG REDUCER**  
**FLANGE REDUCER**



1-1/2" FLNG X 1" 3" x 1-1/2"  
 SFCM200100CPG SFCM300200CPG  
 2" FLNG X 1-1/2" 3" X 2"  
 SFCM220200CPG SFCM300220CPG

**CPG90**  
**FLANGE X  
 FLANGE 90°**



SFCM100CPG90 1" X 1"  
 SFCM200CPG90 1-1/2" X 1-1/2"  
 SFCM220CPG90 2" X 2"  
 SFCM300CPG90 3" X 3"

**CPG**  
**FLANGE**



2" FLNG X 2" FLNG  
 SFCM220CPG

**LEGEND**

A	ADAPTOR
BRB	HOSE BARB
HB	HOSE BARB
HBT	HOSE BARB TEE
CPG	COUPLING
CR	CROSS
MPT	MALE PIPE THREAD
PLG	PLUG
FPT	FEMALE PIPE THREAD
TEE	FLANGE TEE
VV	VENTURI VALVE
Y45	45° Y
Y45G	45° Y W/ GAUGE
CAM	CAMLOCK

# POLY FLANGE FITTINGS

**CPG**  
FLANGE LONG



**2" X 2" X 6" LONG**  
SFCM220CPG6  
**3" FLNG X 3" FLNG X 4" LONG**  
SFCM300CPG

**CR**  
FLANGE CROSS



SFCM100CR **1"**  
SFCM200CR **1-1/2"**  
SFCM220CR **2"**  
SFCM300CR **3"**

**MPT**  
FLANGE X MPT



SFCM100MPT **1"**  
SFCM200MPT **1-1/2"**  
SFCM220MPT **2"**  
SFCM300MPT **3"**

**MPT REDUCER**  
FLANGE X MPT



SFCM1000075MPT **1" X 3/4"**

**PLG FPT**  
FLANGE PLUG W/FEMALE PIPE THREAD



**1" X 1/4"**  
SFCM100PLG025

SFCM200PLG025 **1-1/2" X 1/4"**  
SFCM200PLG075 **1-1/2" X 3/4"**  
SFCM200PLG100 **1-1/2" X 1"**  
SFCM220PLG075 **2" X 3/4"**

**3" X 3/4"**  
SFCM300PLG075

**PLG**  
FLANGE PLUG



SFCM100PLG **1"**  
SFCM200PLG **1-1/2"**  
SFCM220PLG **2"**

**FPT**  
FLANGE X FPT



SFCM100FPT **1"**  
SFCM200FPT **1-1/2"**  
SFCM220FPT **2"**  
SFCM300FPT **3"**

**TEE**  
FLANGE TEE



SFCM100TEE **1"**  
SFCM200TEE **1-1/2"**  
SFCM200100TEE **1-1/2" X 1"**  
SFCM220100TEE **2" X 1"**  
SFCM220TEE **2"**  
SFCM300TEE **3"**

**VV**  
FLANGE VENTURI VALVE



SFCMHV220A **2"**

**Y45**  
COUPLING 45° Y FLANGE



SFCM220Y45 **2"**  
SFCM300Y45 **3"**

**Y45G**  
COUPLING 45° Y FLANGE W/3/4" GAUGE PORT



SFCM220YG45 **2"**  
SFCM300YG45 **3"**

**CAM**  
FLANGE/FEM CAM



**2" FLNG X FEM CAM**  
SFCM220D  
**3" FLNG X 3" FEM CAM**  
SFCM303D

**FLNG GASKET**



SCLG100 **1"**  
SCLG200 **1-1/2"**  
SCLG220 **2"**  
SCLG300 **3"**

SCLG220V **VITON 2"**  
SCLG300V **VITON 3"**

**CLAMPS**



SFCC100 **1"**  
SFCC200 **1-1/2"**  
SFCC220 **2"**  
SFCC300 **3"**



# NOZZLE BODIES

**NOZZLE BODY  
1/4" ADAPTOR**



SNZ36762

**NOZZLE BODY  
1/4" ADAPTOR**



SNZ8474 **NYLON**

**NOZZLE BODY  
CROSS**



SNZT01CR **3/8" HB W/NUT**  
SNZT03CR **1/2" HB W/NUT**

**NOZZLE BODY  
ELBOW**



SNZT01EL **3/8" HB W/NUT**  
SNZT03EL **1/2" HB W/NUT**  
SNZT04EL **3/4" HB W/NUT**

**NOZZLE BODY  
STRAIGHT**



SNZT01ST **3/8" HB W/NUT**  
SNZT03ST **1/2" HB W/NUT**

**NOZZLE BODY  
TEE**



SNZT01TE **3/8" HB W/NUT**  
SNZT03TE **1/2" HB W/NUT**  
SNZT04TE **3/4" HB W/NUT**

**NOZZLE BODY  
CAP**



SNZT03CA

**GASKET FOR  
SNZT03A**



SNZT03GASKET

**NOZZLE INSERT**



SNZT3638 **3/8" HB**

**NOZZLE EL DCV  
HI PRESSURE**



SNZQJ22251 **1/2" HB**  
SNZQJ11750 **3/4" HB**

**NOZZLE TEE DCV  
HI PRESSURE**



SNZQJ22252 **1/2" HB**  
SNZQJ12750 **3/4" HB**

**NOZZLE BODY**



SNZQJ14T **1/4" FPT**

**NOZZLE BODY  
ADAPTOR**



SNZQJ14TT **1/4" MPT**

**NOZZLE BODY  
ADAPTOR**



SNZQJ22674 **1/4" MPT**

**NOZZLE QUICK  
SPLIT EYE**



SNZQJ17560 **3/4" NY**  
SNZQJ17560-1 **1"**

**NOZZLE TEE STD**



SNZQJ18124 **3/8" HB**  
SNZQJ18125 **1/2" HB**  
SNZQJ18727 **3/4" HB**

# NOZZLE BODIES

## NOZZLE EL STD



SNZQJ18635 3/8" HB  
 SNZQJ18638 1/2" HB  
 SNZQJ18717 3/4" HB

## NOZZLE EL DCV



SNZQJ19349 3/8" HB  
 SNZQJ19215 1/2" HB  
 SNZQJ19217 3/4" HB

## NOZZLE TEE DCV



SNZQJ19350 3/8" HB  
 SNZQJ19225 1/2" HB  
 SNZQJ19227 3/4" HB

## NOZZLE CROSS DCV



SNZQJ19351 3/8" HB

## NOZZLE EL DCV



SNZQJ24217 3/4" HB

## NOZZLE TEE DCV



SNZQJ24227 3/8" HB

## 3 WAY NOZZLE BODY EL



SNZQJ36375EL 3/4" EL

## 4 WAY NOZZLE BODY TEE



SNZQJ36375T 3/4" TEE  
 OPEN 3/4" TEE

## NOZZLE WET BOOM 3 WAY



SNZQJ24216-2 3/4"  
 SNZQJ24216A1 1"

## NOZZLE WET BOOM 1" OPEN 3 WAY



SNZQJ363C-1 1" OPEN

## NOZZLE WET BOOM 3/4" OPEN 4 WAY



SNZQJ364C-3/4

## NOZZLE WET BOOM OPEN 5 WAY



SNZQJ365C-3/4 3/4"  
 SNZQJ365C-1 1"

## NOZZLE BODY



SNZQJ8360 1/4" MPT

## NOZZLE EL 1/2" L DCV THREADED MT



SNZQJ39685-1L LEFT

## NOZZLE EL 1/2" RT DCV THREADED MT



SNZQJ39685-1RT RIGHT

## NOZZLE 2 1/2" DCV THREADED MT



SNZQJ39685-2-50





# NOZZLE BODIES

**NOZZLE BODY  
SPLIT EYE**



SNZQJ742112      1/2"

**NOZZLE EL**  
1/2" HB X 1/4" FPT



SNZQJ8645

**FLOATER  
NOZZLE BODY**  
EL 1-1/2" HB X 1" MPT



SNZ10001

**FLOATER  
NOZZLE BODY**  
TEE 1-1/2" HB X 1" MPT



SNZ10002

**750 DOUBLE SHANK**



SNZQJ38939

**750 SINGLE SHANK**



SNZQJ38938

**NOZZLE BODY  
ADAPTOR**  
11/16X QUICK CAP



SNZQJT-NYB

**NOZZLE QUICK CAP  
GASKET**



SNZQJ19438

**NOZZLE CAP  
ADAPTOR**



SNZQJ4676      1/4"

**NOZZLE BODY  
SWIVEL SINGLE**



SNZ30389      1/4" NPTF

**NOZZLE BODY  
SWIVEL DOUBLE**



SNZ30384      1/4"

**NOZZLE BODY  
QUICK SWIVEL  
SINGLE**



SNZQJ8600      1/4" FPT

**NOZZLE BODY  
SINGLE**



SNZQJ4221N

**BOOMJET CLUSTER  
NOZZLE**



SNZ5800

**BOOMLESS SWIVEL  
NOZZLE C80**



SNZQJ34TOC80

**REPLACEMENT  
BOOMLESS SWIVEL  
NOZZLE C80**



SEE NEXT PAGE FOR  
BRASS NOZZLE TIPS

ALSO ON PAGE: 45

# BRASS NOZZLES

BRASS TIP  
OFFCENTER



STPOC04 #4  
STPOC06 #6  
STPOC08 #8

LARGE BRASS TIP  
BOOMJET  
FOR CLUSTER NOZZLE



STPOC10LT #10  
STPOC20LT #20

BRASS ADAPTOR  
FOR CLUSTER NOZZLE



STPCP8267

FOR CLUSTER NOZZLE



STPCP3819

# NOZZLE CAPS



NOZZLE CAP



NOZZLE CAP



NOZZLE CAP



FLOOD TIP



Item Code	Description
SNZQJ19843	NOZZLE CAP QUICK SHUT-OFF
SNZQJ21950	NOZZLE END CAP ASSEMBLY F/DRIPLESS BODY
SNZQJ25598-1	NOZZLE CAP TEEJET AI, STREAMJET
SNZQJ25612-1	NOZZLE CAP SMALL CAPACITY BLACK
SNZQJ25612-3	NOZZLE CAP SMALL CAPACITY RED
SNZQJ25612-4	NOZZLE CAP SMALL CAPACITY BLUE
SNZQJ25612-6	NOZZLE CAP SMALL CAPACITY YELLOW
SNZQJ25612-8	NOZZLE CAP SMALL CAPACITY ORANGE
SNZQJ3020	NOZZLE CAP HYPRO FLOOD
SNZQJ4676	NOZZLE CAP ADAPTOR 1/4" FPT



SNZQJ19843  
NOZZLE CAP SHUT-OFF



SNZQJ21950  
NOZZLE END CAP ASSEMBLY

## ACCESSORIES & REPAIR

Item Code	Description
SNZQJ19438	NOZZLE QUICK CAP GASKET
SNZQJ21953	NOZZLE DIAPHRAGM CHECK VALVES DIAPHRAGM ONLY EPDM
SNZQJ7717	O-RING-FITS 3 WAY DIAPHRAGM CHECK VALVES



SNZQJ21953  
NOZZLE DIAPHRAGM  
CHECK VALVES DIAPHRAGM  
ONLY EPDM

# NOZZLE ACCESSORIES

## BOOM CLAMPS



Boom Clamp Square/Square



Boom Clamp Square/Round

Item Code	Description
OHCAAA034	CLAMP BOOM 3/4" ROUND NOZZLE BODY TEEJET
OHCAAA111	CLAMP BOOM 1" ROUND NOZZLE BODY TEEJET
OHCAASQ111	CLAMP BOOM SQUARE.1" F/ ROUND. NOZZLE BODY TEEJET
OHCAASQ114	CLAMP BOOM SQUARE 1-1/4" F/ ROUND NOZZLE TEEJET
OHCAQJ111	CLAMP BOOM ROUND 1" F/ SQUARE NOZZLE BODY TEEJET
OHCAQJSQ034	CLAMP BOOM SQ.3/4" F/ SQUARE NOZZLE TEEJET
OHCAQJSQ111	CLAMP BOOM SQUARE.1" F/ SQUARE NOZZLE BODY TEEJET
OHCAQJSQ112	CLAMP BOOM SQUARE 1-1/2" F/ SQUARE NOZZLE TEEJET
OHCAQJSQ114	CLAMP BOOM SQUARE 1-1/4" F/SQ. NOZZLE TEEJET STAINLESS STEEL



Boom Clamp Round/Square



Boom Clamp Round/Round



# MISCELLANEOUS SPRAY SUPPLIES

## VITON MICRO VALVES



SVAB025V 1/4" FPT  
SVAB038V 3/8" FPT  
SVAB05V 1/2" FPT

## MICRO VALVES



1/2" MPT X 3/8" HB SVAB050MPT  
SVAB038HB

## TEXAS IND REMCOR 3 SECTION CONTROLLER



SCSCON2420WP3

## PRESSURE REGULATOR POLY



SVAT23121 1/2"  
SVAT23120 3/4"

## POLY THROTTLING VALVE



SVAT2352034PP 3/4"  
SVAT23520 1/2"

## 1560B PRESSURE REGULATOR



REPLACEMENT PART  
SCSPR1506B

## 2502B SOLENOID BOOM CONTROL COIL



REPLACEMENT PART  
SCSSV2502B1WP

## PRESSURE REGULATOR

3/4" MNPT x 3/4" FNPT



SVAT23120 3/4"

## BRASS PRESSURE REGULATOR



SVAT681534 3/4"

## 3 SECTION BOOM CONTROL VALVE



SVATAA17Y 1"

## MANUAL CONTROL VALVE



SVATAA6B

## ELECTRIC CONTROL VALVE



SCS144A-1

## VALVE CHECK INLINE POLY



SVACH075 3/4" FPT  
SVACH100 1" FPT  
SVACH200 2" FPT  
SVACH300 3" FPT

## STANDARD GAUGE



SGASG60 #60  
SGASG100 #100  
SGASG160 #160  
SGASG400 #400

## GLYCERIN GAUGE



SGAGG60 #60  
SGAGG100 #100  
SGAGG160 #160  
SGAGG300 #300  
SGAGG01004 4" #100  
BACK MOUNT

## STRAINERS

### STEEL POND STRAINER



2" FPT  
SSTST200  
3" FPT  
SSTST300

### HOSE END STRAINER



SSTA663  
SSTA6633  
SSTA6634

1/4"  
3/4"  
1"

### T-LINE STRAINER MINI



1/2" FPT W/50M SCREEN  
SSTAA5050

### T-LINE STRAINER CLEAR MINI



1/2" FPT W/50M SCREEN  
SSTAA5050C

### T-LINE STRAINER MINI



3/4" FPT W/50M SCREEN  
SSTBM07550

### MINI TEE STRAINER



SSTCP45102-3  
SSTBT530

1/2" 50M  
1/2"

### MINI TEE GASKET

1/2" & 3/4"  
SSTAA5050G



### T-LINE STRAINER W/50 MESH SCREEN

WITH FLUSH OUT



3/4" FPT 50M  
SSTBT07550  
1" FPT 50M  
SSTBT10050  
1-1/4" FPT 50M  
SSTBT12550  
1-1/2" FPT 50M  
SSTBT15050

### T-LINE STRAINER FLANGED/MANIFOLD



1" T FLNG 50M  
SSTBT10050FL  
2" T FLNG 50M  
SSTBT20050FL

### REPLACEMENT BOWL DRAIN PLUG & ORING

FOR T STRAINERS

3/4" & 1"  
SSTBTLST100B  
1-1/4" & 1-1/2"  
SSTBTLST150B  
2"  
SSTBTLST200B



### Y STRAINER W/40M SCREEN



3/4" W/O FLUSH OUT  
SSTB07540  
SSTB10040  
SSTB12540

3/4" FPT  
1" FPT  
1-1/4" FPT

### Y STRAINER W/50M SCREEN



SSTB15050  
SSTB20050  
SSTB30050

1-1/2" FPT  
2" FPT  
3" FPT

### FLANGED Y PORT FL



SSTB20050FL  
SSTB22250FL  
SSTB30050FL

1-1/2"  
2"  
3"



# STRAINER SCREENS AND REPAIRS

**REPLACEMENT BOWL FOR Y STRAINER DRAIN PLUG & ORING**



1-1/2" & 2"  
SSTB150C  
1" & 1-1/4" BOWL W/ ORING  
SSTB100C1

**BANJO DRAIN PLUG & O-RING**



SSTB100P 1" & 1-1/4"

---



SSTB100R 1" O-RING  
SSTB200R 2" O-RING

**T-LINE GASKET**



F/ 3/4" & 1" BNJ T  
SSTBT100G  
BWL 1-1/4" & 1-1/2" BNJ T  
SSTBT150G

**Y GASKET**



1" & 1-1/4" BNJ Y  
SSTB100G  
1-1/2" & 2" Y  
SSTB200GN  
3" BNJ Y  
SSTB300GN

**12 MESH SS SCREEN Y STRAINERS**



1-1/2" & 2" Y 12M  
SSTB212  
3" Y 12M  
SSTB312

**16 MESH SS SCREEN T-LINE**



1-1/4" & 1-1/2" T 16M  
SSTBT1516

**20 MESH SS SCREEN Y STRAINERS**



1" & 1-1/4" Y 20M  
SSTB120

**30 MESH SS SCREEN**



1-1/4" & 1-1/2" T 30M  
SSTBT1530  
1-1/2" & 2" Y 30M  
SSTB230S

**40 MESH SS SCREEN**



1/2" & 3/4" Y 40M  
SSTB740  
1" & 1/4" Y 40M  
SSTB140

**50 MESH SS SCREEN**



3/4" & 1" T 50M  
SSTBT150  
1-1/4" & 1-1/2" T 50M  
SSTBT1550  
2" T 50M  
SSTBT250SS  
3" Y 50M  
SSTB350

**80 MESH SS SCREEN**



1/2" & 3/4" Y 80M  
SSTB780  
1" & 1-1/4" Y 80M  
SSTB180  
1-1/4" & 1-1/2" T 80M  
SSTBT1580

**100 MESH SS SCREEN**



3/4" & 1" T 100M  
SSTBT1100

# HOSE

## CLEAR VINYL

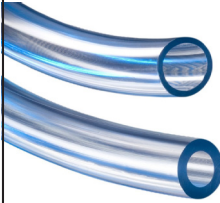

PART#	THICKNESS	ID	WP#
HOCV018	1/16"	1/8"	35
HOCV014116	1/16"	1/4"	35
HOCV038116	1/16"	3/8"	40
HOCV012116	1/16"	1/2"	25
HOCV058116	1/16"	5/8"	40
HOCV034116	1/16"	3/4"	35
HOCV01418	1/8"	1/4"	40
HOCV03818	1/8"	3/8"	60
HOCV01218	1/8"	1/2"	30
HOCV05818	1/8"	5/8"	40
HOCV03418	1/8"	3/4"	35
HOCV118	1/8"	1"	25
HOCV11414	1/4"	1-1/4"	40
HOCV11214	1/4"	1-1/2"	35

100' ROLL

## REINFORCED VINYL



PART#	SIZE	WP#
HOCVR038	3/8"	225
HOCVR012	1/2"	200

100' ROLL

## EPDM HOSE



PART#	SIZE	WP#
HOEP038	3/8"	200
HOEP012	1/2"	200
HOEP058	5/8"	250
HOEP034	3/4"	200
HOEP1	1"	200
HOEP114	1-1/4"	200
HOEP112	1-1/2"	200
HOEP2	2"	200

100' ROLL

## EPDM HOSE W/ WIRE



PART#	SIZE	WP#
HOSU112	1-1/2"	150
HOSU2	2"	120
HOSU3	3"	85

100' ROLL

## HIGH PRESSURE



PART#	SIZE	WP#
HOSP38	3/8"	600
HOSP12	1/2"	600

100' ROLL

## "BUMBLE BEE" FERTILIZER SOLUTION



100' ROLL

PART#	SIZE	WP#
HOFS01	1"	80
HOFS114	1-1/4"	70
HOFS112	1-1/2"	60
HOFS2	2"	60
HOFS3	3"	50
HOFS4	4"	45

## "ENFORCER" REINFORCED FERTILIZER SOLUTION



100' ROLL

PART#	SIZE	WP#
HOFSK112	1-1/2"	100
HOFSK2	2"	100
HOFSK3	3"	85

## PVC SUCTION/ DISCHARGE



100' ROLL

PART#	SIZE	WP#
HOPVS0034	3/4"	100
HOPVS01	1"	90
HOPVS114	1-1/4"	70
HOPSV112	1-1/2"	70
HOPVS02	2"	60
HOPVS03	3"	50

## PVC FLAT DISCHARGE



100' ROLL

PART#	SIZE	WP#
HOEPD2112	1-1/2"	70
HOEPD2	2"	75
HOEPD23	3"	55

## "T-BOLT" CLAMPS ALL STAINLESS STEEL



PART#	DESCRIPTION
OHCT910	1.3"-1.7"
OHCT912	1.62"-1.87"
OHCT913	1.81"-2.06"
OHCT914	1.93"-2.18"
OHCT916	2.18"-2.50"
OHCT917	2.31"-2.62"
OHCT920	2.87"-3.18"
OHCT921	3.31"-3.62"
OHCT922	3.43"-3.75"
OHCT924	4.25"-4.56"

## "WORM" CLAMPS ALL STAINLESS STEEL



PART#	DESCRIPTION
OHC04	1/4"-5/8"
OHC05	5/16"-7/8"
OHC06	7/16"-25/32"
OHC08	1/2"-1"
OHC10	9/16"-1-1/16"
OHC12	11/16"-1-1/4"
OHC16	5/8"-1-1/2"
OHC20	13/16"-1-3/4"
OHC24	1-1/16"-2 ZZ
OHC28	1-5/16"-2-1/4"
OHC32	1-9/16"-2-1/2"
OHC36	7/8"-2-3/4"
OHC40	1-1/8"-3"
OHC52	15/16"-3-3/4"
OHC72	2-3/16"-5"



# HOSE REELS

**HOSE REEL  
ELECTRIC**



MACHRE100 1" X 100'

**HOSE REEL  
MANUAL**



MAC32106 100'  
MAC32112 200'  
MAC32118 325'

**HOSE REEL  
ELECTRIC**



MAC32106E 100'  
MAC32118E 325'

**HOSE REEL  
MANUAL**



MACHR-75 75'

**HOSE REEL  
STAINLESS STEEL  
SWIVEL**



MAC600888-3 1" X 100'

**HOSE REEL  
REPLACEMENT  
FOR ENDURAPLAS**



ASRESWIVEL

# SMALL SPRAYERS

**BATTERY POWERED  
BACK PACK  
14.4V SPRAYER**



MACS600 4 GALLON

**BACK PACK  
14.4V SPRAYER  
REPLACEMENT BATTERY**



MACS401BAT 4 GALLON

**BACK PACK  
PUMP SPRAYER**



MACS405 4.23 GALLON

**HANDHELD  
SPRAYER**



MAC90708 2.1 GALLON

**HANDHELD  
SPRAYER**



MAC90700002 1/2 GALLON

**HANDHELD  
SPRAYER**



MAC90700012 .26 GALLON

# HAND WANDS

**23" ALUMINUM  
JET STREAM  
NO DRIP**



SSPAA11005

**13" TRIGGER GUN  
JET STREAM  
NO DRIP**



SSPAA170013

**22" TRIGGER GUN  
JET STREAM**



SSPAA170022

**LAWN SPRAY GUN**



SSPAA25660-1.5  
SSPAA25660-3.0

**NOZZLE TIP  
FOR LAWN SPRAY GUN**



SSPAA25670-1.5	1.5
SSPAA25670-3.0	3.0
SSPAA25670-4.0	4.0

**26" LONG RANGE  
TRIGGER GUN**



SSPAA3200

**16" LONG RANGE  
ADJUST PISTOL GRIP**



SSPAA28END

**REPAIR KIT  
FOR 16" ADJUST**



SG-2200KIT-CSK





# HAND WANDS

**3/8" FPT 18" ALUMINUM  
PISTOL GRIP**



SSPAA552418

**21" HANDWAND  
ALUMINUM**



SSPAA20800

**ALUMINUM  
AA43L 0-200PSI**



SSPAA43L

**BRASS  
AA43L 0-200PSI**



SSPAA43L6

**ALUMINUM SHORT  
0-200PSI**



SSPAA43LA

**9" ALUMINUM  
PISTOL GRIP**



SSPAA5500189

**18" ALUMINUM  
PISTOL GRIP**



SSPAA55001818

**24" ALUMINUM  
PISTOL GRIP**



SSPAA55001824

# FLAT FAN TIPS

Item Code					
STP01F80 #1	STP15F80 #1.5	STP02F80 #2	STP03F80 #3	STP04F80 #4	STP05F80 #5
STP06F80 #6	STP08F80 #8	STP10F80 #10	STP15F8 #15	STP20F80 #20	

## Standard Flat Fan Tips

Suggested spray height:  
80° = 24" - 26"  
110° = 14" - 16"



### Features:

- Economical option for general spraying.
- Simple one-piece design.
- Polyacetal construction for superior product life compared to stainless steel or brass.

# FLAT FAN W/SS INSERT TIPS

Stainless Steel Inserts					
Item Code					
STP8001VS #1	STP80015VS #1.5	STP8002V #2	STP8003VS #3	STP8004VS #4	STP8005VS #5
STP8006VS #6	STP8008VS #8				

### SS. Features:

- Excellent spray distribution over a wide range of pressures- 15-60 PSI (1-4 bar).
- Ideal for rigs equipped with sprayer controllers.
- Reduces drift at lower pressure, better coverage at higher pressures.
- Available in stainless steel, ceramic and polymer in 80° and 110° spray angles with VisiFlo color-coding.



# AIR INDUCTION SPRAY ULD TIPS

Item Code					
STPAI120015 #1.5	STPAI12002 #2	STPAI120025 #2.5	STPAI12003 #3	STPAI12004 #4	STPAI12005 #5
STPAI12006 #6	STPAI12008 #8				



### Features:

- 110° wide, tapered flat spray angle with air induction technology offers better drift management.
- Made of a two-piece UHMWPE polymer construction with VisiFlo color-coding.
- UHMWPE provides excellent chemical resistance, including acids, as well as exceptional wear life.
- Compact size to prevent tip damage.
- Depending on the chemical, produces large air-filled drops through a Venturi air aspirator.
- Removable pre-orifice.
- Available in eight tip capacities with a wide operating pressure range: 15-90 PSI (1-6 bar).



# WIDE ANGLE FLAT FAN TIPS

Item Code								
STPTT11001VP	STPTT110015VP	STPTT11002VP	STPTT110025VP	STPTT11003VP	STPTT11004VP	STPTT11005VP	STPTT11006VP	STPTT11008VP
#1	#1.5	#2	#2.5	#3	#4	#5	#6	#8

**Features:**

- Tapered edge wide angle flat spray pattern for uniform coverage in broadcast spraying
- Large, rounded internal passage to minimize clogging
- Excellent resistance to corrosive solutions
- Larger droplets for less drift -- 15-90 PSI (1-6 bar).
- Automatic spray alignment
- Blockage-free passage means less clogging
- Unique internal configuration means substantially longer wear life.

# FLAT FAN TWIN TURBO

Item Code			
STPTTJ11002	STPTTJ11003	STPTTJ11004	STPTTJ11005
#2	#3	#4	#5

**Features:**

- Excellent resistance to corrosive solutions.
- Superior wear characteristics.
- Larger droplets for less drift 15-90 PSI (1-6 bar).
- Unique internal configuration means substantially longer wear life.

# AIR INDUCTION SPRAY TIPS

Item Code							
STPAI110015-VS	STPAI11002-VS	STPAI110025-VS	STPAI11003-VS	STPAI11004-VS	STPAI11005-VS	STPAI11006-VS	STPAI11008-VS
#1.5	#2	#2.5	#3	#4	#5	#6	#8

**Features:**

- Stainless steel insert produces a tapered edge flat spray pattern.
- Polymer insert holder and pre-orifice with Visiflow color-coding.
- Larger droplets for less drift.
- Available in eight capacities with a recommended pressure rating 30-115 PSI.
- Depending on the chemical, produces larger air-filled drops through the use of a Venturi air aspirator.

# FLOODJET TIPS

Item Code	
STPAN05 #.5	STPAN075 #.75
STPAN1 #1	STPAN15 #1.5
STPAN2 #2	STPAN25 #2.5
STPAN3 #3	STPAN4 #4
STPAN5 #5	STPAN75 #.75
STPAN10 #10	STPAN150 #15
STPAN20 #20	

**TK-VP FLOODJET®**

# FLOODJET SS TIPS

STAINLESS STEEL 1/4" (B) 1/4 FLOODJET®

Item Code	STPFK3 SS #3	STPFKSS5 SS #5	STPFKSS7.5 SS #7.5	STPFKSS12 #12	STPFKSS15 #15
-----------	-----------------	-------------------	-----------------------	------------------	------------------

**PENTAIR**  
HYPRO®

# FLOODJET SS TIPS

STAINLESS STEEL 1/4" (B) 1/4 FLOODJET®

Item Code	STPTKVS2 #2	STPTKVS2.5 #2.5	STPTKVS3 #3	STPTKVS4 #4	STPTKVS5 #5
-----------	----------------	--------------------	----------------	----------------	----------------

**Features:**

- Excellent spray distribution for uniform coverage along the boom
- Spray tip design incorporates a pre-orifice to produce larger droplets for less drift.
- Large, round orifice reduces clogging.
- Available in five VisiFlo Stainless Steel and seven VisiFlo Polymer capacities.

**TeeJet®**  
TECHNOLOGIES

# LIQUID FERTILIZER TIPS

Item Code	STPSJ3015VP #1.5	STPSJ302VP #2	STPSJ303VP #3	STPSJ304VP #4	STPSJ305VP #5	STPSJ306VP #6	STPSJ308VP #8	STPSJ310VP #10	STPSJ315VP #15
-----------	---------------------	------------------	------------------	------------------	------------------	------------------	------------------	-------------------	-------------------

**Features:**

- Tapered edge wide angle flat spray pattern for uniform coverage in broadcast spraying.
- Large, rounded internal passage to minimize clogging
- Excellent resistance to corrosive solutions
- Superior wear characteristics.
- Larger droplets for less drift - 15-90 PSI (1 - 6 bar).
- Automatic spray alignment
- Blockage-free passage means less clogging
- Unique internal configuration means longer wear life.

**TeeJet®**  
TECHNOLOGIES



# FAST CAP ESI SIX STREAM

**Item Code**

STPESI11003 #3	STPESI11004 #4	STPESI11005 #5	STPESI11006 #6	STPESI11008 #8	STPEFCESI110015 #15
-------------------	-------------------	-------------------	-------------------	-------------------	------------------------

**Stream Spray Tips**

- Six streams distribute fertilizer more evenly than one single stream
- Reduced atomization limits leaf burn and scorching
- Wear-resistant ceramic orifice



# HYPRO GUARDIAN TIP

**Item Code**

STPGRD12002 #2	STPGRD12003 #3	STPGRD12004 #4
-------------------	-------------------	-------------------

• The Hypro GuardianAir is the only spray tip with a pattern and droplet size scientifically designed to maximize coverage and productivity at spray rates around 10 GPA.



# GUARDIAN AIR 110°

**Item Code**

STPGA11002 #2	STPGA11003 #3	STPGA11004 #4	STPGA11005 #5
------------------	------------------	------------------	------------------

**Wide Angle Coverage plus drift control.**

- Straight-through design to reduce clogging and drift
- Incredibly uniform application across the boom
- Lower spray heights and pre-orifice technology reduce drift
- Fits directly on standard nozzle bodies
- Includes tip, cap and gasket



# HYPRO GUARDIAN AIR TWIN

**Item Code**

STPGAT02 #2	STPGAT03 #3	STPGAT04 #4	STPGAT05 #5	STPGAT08 #8
----------------	----------------	----------------	----------------	----------------

**Features:**

- Ideal for low crops with complex canopies, such as vegetables, where thorough coverage of the target and protection of the surroundings are of high importance.
- High-coverage forward and rear-facing fans provide coverage on both sides of target.
- FastCap complete includes nozzle, cap, gasket and is available with or without a filter.
- Integrated strainers are matched to the nozzle size to prevent over-straining or plugging.



# HYPRO HI-FLOW FASTCAP

**Item Code**

STPHF14008 #8	STPHF14010 #10	STPHF14015 #15
------------------	-------------------	-------------------

**Features:**

- Excellent for high volume coverage or high speed applications.
- Wide spray angle (140°) allows for lower spray height or reduce drift.
- Patented straight-through design reduces clogging and easily fits directly on standard nozzle bodies.



# STREAM BAR 15" & 20"

Item Code	
STPMR15	STPMR20
15"	20"

15" & 20" CENTERS

### O-RING & SCREEN

Item Code	
STPMRO-RING	STPMRSCREEN
O-RING	SCREEN

FOR STREAM BAR

# HYPRO BOOM X-TENDER NOZZLES

Item Code			
SNZBB10	SNZBB20	SNZBB24	SNZBB43
#10	#20	#24	#43
1/4" MPT	1/4" MPT	1/4" MPT	3/8" MPT

\*One nozzle 12-15 ft. spray swath @ 40 psi

HYPRO®

# FAST CAP BOOM X-Tender Series®

Item Code			
SNZBB10FC	SNZBB20FC	SNZBB24FC	SNZBB43FC
#10	#20	#24	#43

- Works with or without booms
- Eliminate broadcast booms and associated plumbing

Excellent for:

- water ways
- road ways
- ditches
- fence rows
- pastures

# REPAIR KITS

Item Code				
SNZBB10KIT	SNZBB20KIT	SNZBB24KIT	SNZBB43KIT	SNZBB80KIT
#10	#20	#24	#43	#80

# MISTER

Item Code
STPM.7

1/8" THREADED

### POLY NOZZLE FILTER

SNF1701 BLUE 50M  
SNF1702 GREEN 100M

### NOZZLE FILTER

SNFPP50 BLUE 50M  
SNFPP100 GREEN 100M

### BOOMJET CLUSTER NOZZLE

SNZ5800

### BOOMLESS SWIVEL NOZZLE C80

SNZQJ34TOC80



# GARDEN HOSE MENDING

**THREADED TIP PISTON NOZZLE**



DAH573

**GARDEN HOSE**



3/4" MT X 3/8" HB  
SHBGA106

3/4" MT X 1/2" HB  
SHBGA108

3/4" MGHT X 3/4" HB  
SHBGE2012

**GARDEN HOSE BARB**



HB SWL 1/4" HB  
SHBGHA4

HB SWL 3/8" HB  
SHBGHA6

HB SWL 1/2" HB  
SHBGHA8

HB SWL 3/4" HB  
SHBGHA12

**GARDEN HOSE ADAPTOR**



1/2" MPT X 3/4" MT  
SPFGPN8

3/4" MPT X 3/4" MPT  
SPFGPN12

**GARDEN HOSE ADAPTOR**



3/4" FGHT X 1/2" FPT  
SPFGHF128

3/4" FGHT X 3/4" FPT  
SPFGHF1212

**GARDEN HOSE EL HB ADAPTOR**



3/4" MT X 3/4" HB ELBOW  
SPFGEL12

**GARDEN HOSE CAP**



SPFGHC12

**GARDEN HOSE WASHER**



SPFGHW12

**GARDEN HOSE NUT SWIVEL**



FOR 3/4" HOSE  
SPFGHN12

**CAMLOCK GARDEN HOSE ADAPTOR**



3/4" MC X 3/4" FGHT  
SCLG075F

**CAMLOCK GARDEN HOSE ADAPTOR**



3/4" FC X 3/4" MGH  
SCLG075B

**CAMLOCK GARDEN HOSE ADAPTOR**



3/4" FC X 3/4" FGHT  
SCLG075D

**CAMLOCK GARDEN HOSE ADAPTOR**



3/4" M X 3/4" FGHT  
SCLG075A

**GARDEN HOSE Y**



3/4" MGHT X 1/2" HB  
SPFGWY1288

**GARDEN HOSE ADAPTOR**



3/4" FT X 3/4" MPT  
SPFGMA12

**3/4" GH 1/2" PO BRS QK DISCNT**



SPFGHQD003

**BRASS QUICK CONNECTOR SET**



OR09QC

# 2024 CATALOG

MANUFACTURING QUALITY AG EQUIPMENT SINCE 1962  
FAMILY OWNED AND OPERATED

800-299-4300 / 580-234-3434  
PARTS COUNTER - EXT. 407, 409  
PARTS COUNTER EMAIL - STORE@WAKOLLC.COM

5606 N. US 81 HWY  
ENID, OK. 73701

VISIT

---

WAKOLLC.COM



YOUTUBE



TIK TOK



FOLLOW US

---

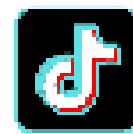

2024 © WAKO LLC

580-234-3434  
800-299-4300

5606 N. US 81 HWY,  
ENID, OK. 73701

WAKOLLC.COM



EST. 1962